

Smart room Automation using sensors and GSM module

P.Vinoth Kumar¹, P.Sathish Khanna², Arthi J³, Arul Rajan P⁴, Arunkumar S⁵

¹Associate Professor, Department of Electrical and Electronics Engineering, Sri Krishna College of Engineering and Technology, Kuniamuthur, Coimbatore, India.

²Department of Marine Engineering, AMET Deemed to be University, Chennai.

^{1,3,4,5} UG Scholar, Department of Electrical and Electronics Engineering, Sri Krishna College of Engineering and Technology, Kuniamuthur, Coimbatore, India.

Email: ¹vinothkumarktp@gmail.com, ²sathishkhanna86@gmail.com, ³arthikyr@gmail.com, ⁴19euee020@skcet.ac.in, ⁵19euee023@skcet.ac.in

Abstract- *In the field of information and communication technology (ICT), the Internet of Things (IoT) has gotten a lot of interest in recent years. The internet-based interconnection of various computing devices embedded in daily appliances that allows them to speak with one another is referred to as the Internet of Things (IoT). This improves the end user's quality of life while also increasing efficiency and sustainability in day-to-day tasks. This study looks into the possibilities of 'Full Home Control,' which is the goal of Home Automation Systems in the not-too-distant future. The study and application of smart home automation technologies using the NodeMCU ESP8266, the Blynk app, and sensors to control household appliances such as lights and thermostats. The current research effort enables household appliances to be controlled via the internet over a wireless Fidelity Wifi connection using a node MCU and several sensors such as the LM35 sensor, PIR sensor, and LDR sensor. As a result, there is no need to inspect them frequently. Homeowners will be able to receive feedback on the status of any household appliances they control remotely, whether they are turned on or off. A fan, light, and plug were used in the suggested prototype of a NodeMCU-based home automation system.*

Keywords - *Home automation; IOT (Internet of Things); NodeMCU ESP8266; Blynk; LM35 sensor; PIR sensor; LDR sensor.*

1. INTRODUCTION

Customers are becoming increasingly interested in smart homes. A smart house is one that has networked electrical devices that can be controlled remotely. Automating your home with smart technology [1] involves the ability to manage and monitor home features such as lighting, climate, entertainment systems, and appliances from a smart phone, whether at home or thousands of kilometres away. [2]. It also offers home security features such as access control and video surveillance. [3]. The internet of things (IoT) is the process of linking a large number of computing devices built in common household appliances to the internet and allowing them to communicate with one another [4]. Many smart devices will be interacting over IoT in the near future. [5]. According to Gartner, there will be more than 20 billion connected devices by 2020, rising to 25 billion by 2021. Consider a future when your personal refrigerator develops a list of all the things, you'll need in the next days based on

your current use. Each household item, such as a television, light bulb, or fan, is given a unique address, and they are all connected through a single home gateway. These may be accessed and operated remotely from any PC, mobile device, or laptop. This can significantly reduce energy usage and improve the living environment while also increasing indoor safety. As a result of rapid technology breakthroughs, devices have recently gotten smarter. Real-world appliances are becoming smarter and more powerful, allowing them to configure themselves correctly. [6]. Sensors on embedded devices, along with low-power wireless communication, make it possible to remotely monitor and control them. This is an important part of the IoT network. IoT also aids in the transmission of data from sensors via a wireless network, as well as the recognition and sharing of information in an open computing network. Things we use in our daily lives are becoming smarter thanks to current technologies, but it won't be enough until we connect them so that they can interact with the dynamic environment and create their own inter-network, or machine-to-machine communication. To use readings from several sensors set throughout the house to automate the operation of some key household appliances such as fans, lights, and plugs. [7]. The Node MCU ESP8266 will be connected to the LDR, HC-SR 501, and LM35 sensors, which will process the sensor data and control the relays connected to the appliances. The suggested system consists of three loads that are controlled by a node MCU microcontroller. In their work titled "Smart Power Socket utilising Internet of Things," they created a power socket that is controlled via wifi. [8]. The system's flaw is that it lacks a well-established communication channel between the user and the device. [9]. In this paper "MQTT based home automation system utilising ESP8266," uses the message protocol MQTT. The drawback of this protocol is that it uses TCP, which necessitates greater computing power and memory. TCP employs a handshake protocol that necessitates periodic wake-up and communication intervals. This has an impact on battery use. Where the area covered by Bluetooth has low coverage, a work titled "Controlling Smart Home Automation using Bluetooth and GSM " was recommended. [10]. They created and deployed a wifi-based home automation system as part of their work [11]. A model based on a GSM-based home automation system was proposed.

SYSTEM REALIZATION

Electrical equipment has improved dramatically as a result of the rise in the field of IoT. Research and analysis are still being carried out in order to increase the quality of those devices. This improves home security while also allowing for the addition of additional gadgets and appliances. A microcontroller node MCU is used to control household appliances, and a GSM module is used to establish communication between the user and the system in the proposed paradigm. Blynk is a mobile app that allows you to control your loads. Sensors such as LDR, LM 35, and PIR sensors are used to turn appliances on and off automatically. Blynk contains a variety of features, such as a timer and a feedback system.

SENSORS AND GSM MODULE SMART HOME AUTOMATION AND CONTROL SYSTEM

The proposed model's block diagram is shown in Figure 1. Node MCU and Blynk make up the architecture. In this model, the blynk app is utilised to establish a link between the user and the microcontroller. The user's ON/OFF command is sent to the NodeMCU ESP8266 via the blynk app. The micro controller processes the command and sends the output to the relay, which controls whether the home appliances are on or off. [12]. In Figure 1, the GSM module is utilised to establish connection between the user and the system.

Fig. 1. Overall Block Diagram

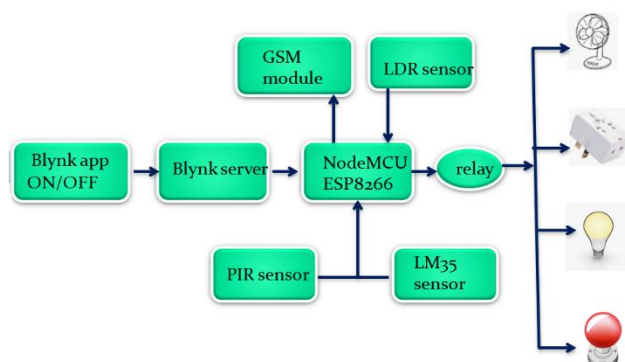

Figure 2 shows the sensor block diagram. The sensor readings are sent to the MCU ESP8266 node, where the values are analysed and the loads are automatically regulated via the relay. A voltage regulator circuit converts the 230 V AC supply voltage to 5 V DC. The NodeMCU and 5V relay are both powered by a 5V dc supply.

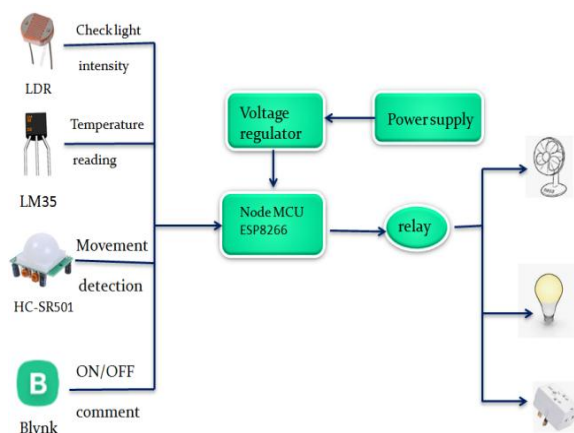

Fig.2.Sensor Block diagram

A. NodeMCU

The Node MCU is connected to a smartphone's internet hotspot through wifi. Node MCU is a Lua-based open-source firmware and development board designed specifically for Internet of Things (IoT) applications. It comes with firmware for the ESP8266 Wi-Fi SoC. The device is powered by a USB port. 3.3 volts is the operating voltage. It contains 16 Digital I/O (DIO) pins and 1 Analog Input (ADC) pin[13]. These pins are used to connect the sensors. 4 MB of flash memory a little module that can be used in IoT projects.

B. Relay KIT

The load is driven by the relay from the digital Node MCU output pins. It's made up of four 5v relays, as well as switching and isolating components. Each relay's contacts are rated for 250 volts, 30 volts, and 10 amps. A relay is a device that acts as a switch. The relay shuts the circuit and sends current to the load linked to it after it is triggered by the Node MCU. Relay is important because it acts as a link between 230VAC supply and 5VDC supply [14].

C. Voltage regulator – LM7805

The LM 7805 is an integrated circuit that converts any voltage between 9 and 12 volts to a constant +5 volts. It's a three-pin integrated circuit. The incoming DC voltage is accepted by the input pin, which is then regulated down to 5v by the regulator. The regulator's ground is established by the ground pin. The output pin provides a 5V DC output that is regulated. The LM7805's fixed output voltage (+5v) is represented by the last two values. Capacitors can be added to the input and output pins depending on the voltage levels.[15]. The voltage regulator is utilised to supply the components with a 5V supply voltage.

D. Sensors

1. LM 35 sensor

The LM35 sensor can be used to measure a room's temperature. It can detect temperatures between -55°C and 150°C. Its output voltage is directly proportional to temperature (i.e., for every 1°C increase in temperature, the output voltage rises by 10mV). Because of its compact size, it's ideal for remote applications [16]. Low-cost temperature sensor in equations. Voltage is converted to temperature,

$$V_o = 10\text{mv}/^{\circ}\text{c} \times T \quad (1)$$

Where,

V_o - LM35 output voltage, T in °c

2. PIR sensor: HC-SR501

This motion sensor is able to tell the difference between human and object movement. Its function is determined by the amount of heat created by the object. It is ideal for our climate because it can operate at temperatures ranging from -20°C to 80°C. It can operate in two modes: repeatable and non-repeatable. It's made up of two main parts:

- i) The heat signatures of a living organism can be detected using pyroelectric crystals.
- ii) Fresnel lenses broaden the sensor's range and focus infrared light on the pyroelectric sensor.

3. LDR sensor

This sensor detects whether or not there is light present. It converts the energy of light into an electrical signal. It produces a signal that indicates the intensity of light in a very limited band of frequencies called "light." Its light spectrum spans "infrared," "visible," and "ultraviolet." It checks the sunset and assists in turning on the light.

E. GSM module – SIM900A

A microcontroller (or a microprocessor) can interface with the GSM/GPRS network using the GSM module. The SIM900A is a low-cost GSM module that can be utilised in IoT and embedded applications. The SIM900A is a dual-band GSM/GPRS engine that works at EGSM 900MHz and DCS 1800MHz. The SIM900A is a device that has 68 terminals. [17].

F. Software Requirements

Blynk application

Blynk is an iOS and Android software that allows you to control Arduino, Raspberry Pi, and other devices. It allows us to control loads (connected via relay) from a mobile device linked to the internet. It has the ability to control, store, and visualise sensor data. This blynk is linked to the microcontroller, which processes the data and performs the action.

FLOWCHART

The flow chart in Figure 3 depicts how things function. The Node MCU is triggered and powered by a 5V dc source. The wifi connection establishes the link between the blynk app and the Node MCU. The Blynk app checks for the correct Hotspot and password authentication codes. The connection is not formed if the hotspot and password are incorrect.

After confirming that the connection has been established, the user command is sent to the microcontroller as an input. Through the relay, the microcontroller processes the data and controls the home appliances such as the bulb, fan, and socket. The relay is a switch that assists in providing or resisting power to loads. A 5V relay is utilised in this example. The relay connects the 5 V DC power supply to the 230V AC power supply. The GSM module is used to communicate the system's status to the user.

Fig.3. Flowchart

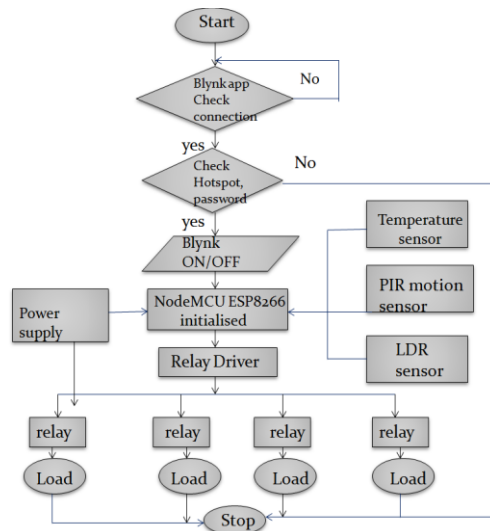

The flowchart shown in Fig.4 can be used to explain how the sensor circuit works. The light intensity is measured by the LDR sensor, which then sends the value to the microcontroller as an input. The resistance of the sensor decreases as the light intensity decreases, allowing current to flow via the microcontroller pin. As a result, the Bulb connected by the relay has a closed circuit. The temperature is measured using an LM 35 sensor. It has a large operational range. The microcontroller receives the results from the LM 35 sensor, which are compared to the acceptable temperature value. The PIR sensor reading is considered once the reading exceeds the limit. The circuit of the Fan connected across the relay is closed if it equals 1 (meaning that human movement is detected). As a result, these sensors are employed to autonomously adjust the loads, reducing human labour.

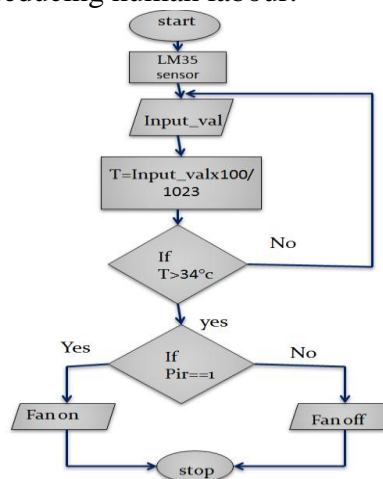

Fig.4.Sensor Flowchart

2. EXPERIMENTAL RESULTS

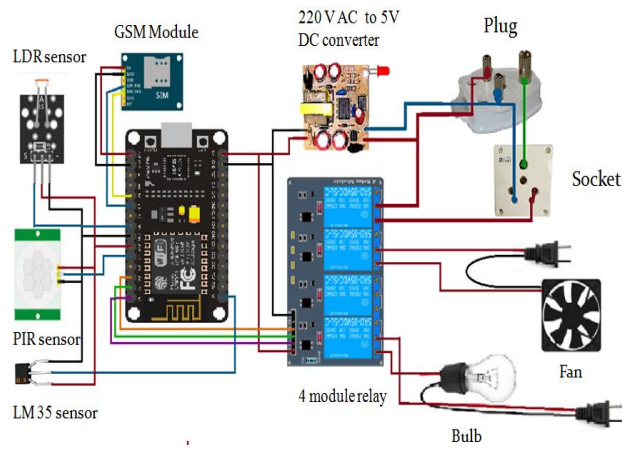

Fig.5. A smart home automation system utilising sensor technology has been proposed.

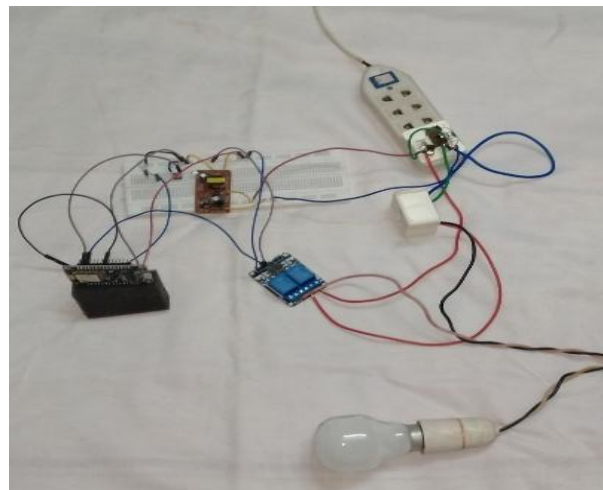

Fig.6. Hardware setup

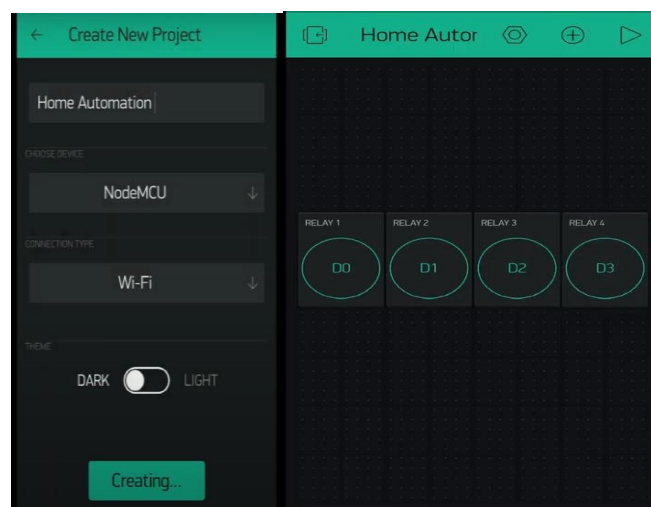

Fig.7. Blynk app used for controlling appliances through mobile

Our proposed model aids in the enhancement of room security. Allows for new devices and appliances to be added with ease. Allows you to operate your home's functions from a distance. Enhances the functionality of the appliance. As a result, energy efficiency improves. It aids users in overcoming their anxiety of overcharging or excessive current usage. Manual interference is greatly reduced, resulting in significant time and energy savings. The main benefit of this system is that it notifies the user of any problems as soon as they occur, potentially saving thousands of dollars in damages.

3. CONCLUSION AND FUTURE WORK

This research looked at the design, construction, and implementation of a portable, user-friendly, and low-cost automation system for Smart rooms based on IoT. This system is set up in such a way that it can control house attributes both manually and automatically. It allows for monitoring and control from even the most remote locations. The study's findings are promising, and the developed system has the potential to improve user safety, security, intelligence, and comfort. Additional sensors and actuators can be added to the proposed system. The developed system can also be enhanced to make it more commercially viable in the future. To make the suggested system more user pleasant, the study will use voice and gesture-controlled home automation. To reduce space, all circuits are optimised using printed circuit boards. We plan to add a messaging system and a voltage monitoring system to the project in the future.

4. REFERENCE

- [1] S. Badabaji and V. S. Nagaraju, "An IoT Based Smart Home Service System," *International Journal of Pure and Applied Mathematics*, vol. 119, no. 16, pp. 4659-4667, 2018.
- [2] S. Badabaji and V. S. Nagaraju, "An IoT Based Smart Home Service System," *International Journal of Pure and Applied Mathematics*, vol. 119, no. 16, pp. 4659-4667, 2018.
- [3] C. Woodford, "Smart homes and the Internet of Things," in *Explain That Stuff*, ed, 2018.
- [4] C. Woodford, "Smart homes and the Internet of Things," in *Explain That Stuff*, ed, 2018.
- [5] T. Malche and P. Maheshwary, "Internet of things (IoT) for building smart home system," in *2017 International Conference on I-SMAC (IoT in Social, Mobile, Analytics and Cloud)(I-SMAC)*, 2017, pp. 65-70: IEEE.
- [6] B. Davidovic and A. Labus, "A smart home system based on sensor technology," *Facta Universities, Series: Electronics and Energetics*, vol. 29, no. 3, pp. 451-460, 2015.
- [7] S. K. Vishwakarma, P. Upadhyaya, B. Kumari and A. K. Mishra, "Smart Energy Efficient Home Automation System Using IoT," *2019 4th International Conference on Internet of Things: Smart Innovation and Usages (IoT-SIU)*, Ghaziabad, India, 2019, pp. 1-4
- [8] S. Karanchery and N. Rakesh, "Smart Power Socket using Internet of Things," *2020 International Conference on Inventive Computation Technologies (ICICT)*, Coimbatore, India, 2020, pp. 1060-1064, doi: 10.1109/ICICT48043.2020.9112377.

- [9] R. K. Kodali and S. Soratkal, "MQTT based home automation system using ESP8266," in 2016 IEEE Region 10 Humanitarian Technology Conference (R10-HTC), 2016, pp. 1- 5: IEEE.
- [10] G Jegadeeswari, (2019)“Performance Analysis of Power Quality Improvement using Shunt Active Power Filter” International Journal of Recent Technology and Engineering (IJRTE), 7 (5), 1-3
- [11] G Jegadeeswari, M DHEEPAK, SV Saravanan, V Vanisree, (2018) “The Power Factor Correction Improvement For A Single Phase Ac/Dc Converter Using An Enabling Window Control”, International Journal of Mechanical and Production Engineering Research and Development (IJMPERD), 8, 41-48
- [12] E. Ganesh, "Implementation of IOT Architecture for SMART HOME using GSM Technology," International Journal of Computer Techniques, pp. 2394-2231,2017.
- [13] C. Gnanavel,T. Baldwin Immanuel, “Investigation on Four Quadrant Operation of BLDC motor Using Spartan-6 FPGA”, Springer-Communications in computer and information Science, Volume 8, Issue 837,pp.752-763,2018
- [14] Gnanavel.C, AlbertAlexander.S, “Investigation and Validation of an Eleven Level Symmetric Modular Multilevel Inverter Using Grey Wolf Optimization and Different Evolution Control Algorithm for Solar PV Applications” Volume.47, No.1, PP.117-127, 2020.
- [15] Gokul C, Vanchinathan K,Gnanavel C, “Test Scheduling of Core Based System-on-Chip Using Modified Ant Colony” Journal Européen des Systèmes Automatisés, Volume 52,Issue 6,PP.599-605, 2020.
- [16] M Rajavelan, C Gnanavel, T Baldwin, Immanuel and P Muthukumar, “Improved Sensitivity of SPR Instrument Using Multiple Reflection Technique” International Journal of Engineering & Technology,vol.7,pp. 1310-1316, 2018.
- [17] C Gnanavel, M Rajavelan, P Muthukumar, T Baldwin Immanuel," A Performance Investigation of a Single Phase Multilevel Inverter Fed Nonlinear Loads for Solar PV Applications” vol.7,no.24,pp.388-391,2018.
- [18] S Vidhya, T Sasilatha, (2018) “Secure Data Transfer Using Multi Layer Security Protocol with Energy Power Consumption AODV in Wireless Sensor Networks”Wireless Personal Communications 103 (4), 3055-3077
- [19] M Parameswari, T Sasilatha, (2018)"Cross-layer based error control technique for WSN with modified relay node selection and corruption aware method" Wireless Personal Communications 99 (1), 479-495
- [20] A Priya, T Sasilatha (2017) "Wireless network for strategic boundary supervision system" Bulletin of Electrical Engineering and Informatics 6 (4), 367-370