

Regenerative And Lora Based Conveying Unit For Armed Force Trooper Monitoring System In Shoe

Mrs.S.V.Priya¹, Poothigaivalli.C², Ruth Elizabeth.A³, Sindhuja.S⁴,

¹Department of ECE, Loyola Institute of Technology, Palanchur.

²Department of ECE, Loyola Institute of Technology, Palanchur.

³Department of ECE, Loyola Institute of Technology, Palanchur.

⁴Department of ECE, Loyola Institute of Technology, Palanchur.

Email: ¹srisvpriya@gmail.com

Abstract - The Indian armed force is the land-based branch and it is the biggest part of Indian Army. It will be valuable for our nation's well being on the off chance that we attempt to give them better trend setting innovation hardware. The proposed approach gives us Long Range Radio (LoRa) based well being observing and area global positioning framework for troopers. This sort of cutting edge configuration can be mounted on the fighter's shoe to guarantee their well being. If there should arise an occurrence of death of the warrior, the regulator underwear to the camp office control alongside fighter's area. The proposed framework involves small wearable physiological equipment's, sensor, GPS and transmission modules. Henceforth, it is feasible to carry out an ease system to give required assistance in the combat zone. This data can be utilized to devise war procedures with regards to the number of more officers (and where) ought to be sent to supplant the saints. It assists with limiting the time, search and salvage activity endeavors of armed force control unit.

Keywords – Lora technology, Health monitoring and Location tracking

1. INTRODUCTION

As per the u.s. casualties report by law-makers analysis Service, the casualty outline of varied conflicts like war, Vietnam Conflict, Operation Iraqi Freedom etc. reveals that thousands of yank military personnel died of wounds and tons of were declared missing in action. Back zero in India, as per The Hindu [2], even thirty five years when the India-Pakistan war terminated on Gregorian calendar month seventeenth, 1971, the families of fifty four troopers who were declared 'missing in action' don't grasp the fate of their kin. All in all, around a hundred and sixty million individuals have died in wars, throughout the twentieth century alone. The higher than simply a number of statistics. the fact is that many individuals ar affected, suffer and ne'er see their families once more as a results of the incessant warfare that takes in present time. With the increasing range of missing individuals and fatalities, this drawback must be self-addressed with foremost importance.

EXISTING SYSTEM

Perhaps the greatest test in military activity lays is that the Soldiers can't speak with control room overseer if there should be an occurrence of crisis or when required any assistance. Likewise the current status and area of the troopers can't be distinguished with this framework. The military manager can't send any clinical assistant to give help if there should arise an occurrence of chronic weakness state of troopers. The current strategy likewise doesn't screen the medical issue of the warriors which is more significant at war time. In this manner we move to some trend setting innovation which centers around the security of warriors and furthermore helps the military.

DISADVANTAGES: Live area of the fighters can't be tracked. Soldiers can't get any assistance if there should arise an occurrence of crisis.

PROPOSED SYSTEM

To beat the detriments referenced above we propose a high level model plan to give security to fighters. It is extremely fundamental for the military base station to realize the area just as the wellbeing status of the warriors when they cross the assigned limit. The versatile far off trooper unit comprises of miniature regulator, GPS, temperature sensor and heart beat sensor which screen the ailment and area of warriors. On the off chance that there present any unusual condition the regulator will insinuate about the wellbeing boundaries alongside live area with the assistance of LORA correspondence organization to the control room manager alongside a ringer alert. This will be exceptionally helpful for the control space to make a required move in basic circumstance. Each officer's shoe will have a novel ID which as of now contains all clinical records of the warriors. This assists the clinical helper with giving appropriate clinical treatment dependent on trooper's medical issue. It likewise has a regenerative charging unit to control the shoes by utilizing piezoelectric, while strolling.

ADVANTAGES: Low expense and productive technique. Consistent wellbeing observing is conceivable. Better correspondence among fighters and control room.

**IV.BLOCK DIAGRAM
 SOLDIER SECTION**

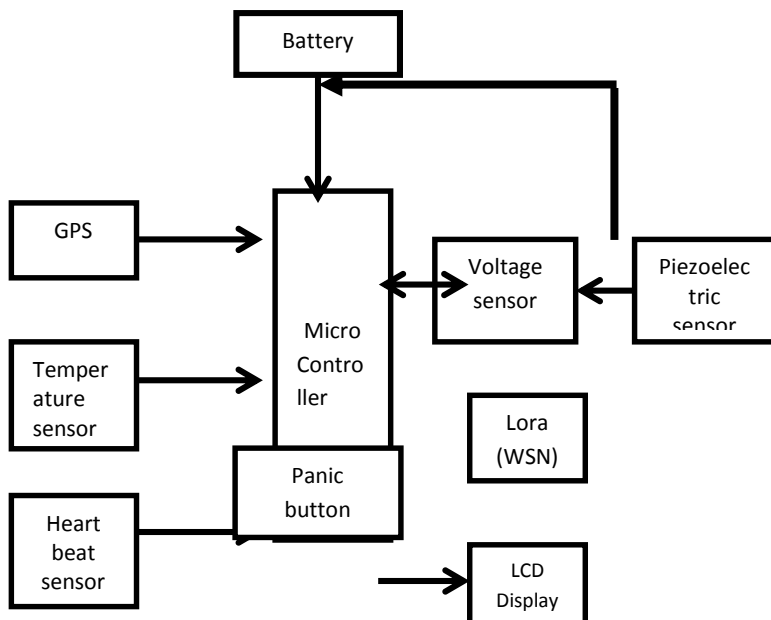



CONTROL ROOM SECTION

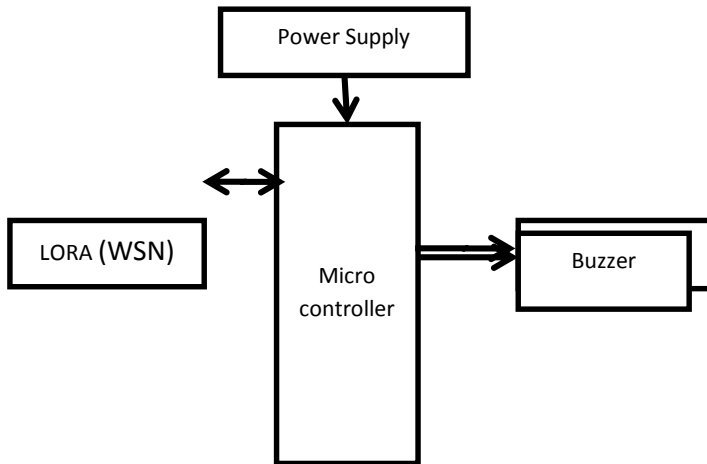

HARDWARE REQUIREMENTS

- Micro Controller
- LORA
- Piezoelectric Sensor
- Temperature Sensor
- Heartbeat Sensor
- Voltage Sensor
- GPS
- LCD Display
- Power Supply
- Battery
- Buzzer

SOFTWARE REQUIREMENTS

- Embedded C
- Arduino IDE

IMPLEMENTATION

POWER SUPPLY: Step-down transformer is utilized to undercover the 230V AC into 12V AC. Rectifier will change over 12V AC into 12V DC. Channel is utilized to diminish consonant sign. Controller is utilized for 12V DC into 5V DC by IC7805. Since the microcontroller will run distinctly in 5V.

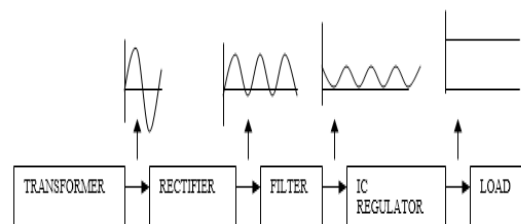

ARDUINO UNO : Arduino UNO could be a microcontroller board smitten by the ATmega328P. it's fourteen advanced info/yield pins (of that vi will be used as PWM yields), six easy knowledge sources, a sixteen MHz quartz gem, a USB association, a force jack, associate ICSP header and a push button. It contains all that expected to assist the microcontroller; primarily interface it to a laptop with a USB link or force it with associate AC-to-DC connective. Arduino UNO has varied offices for speaking with a laptop, another Arduino board, or alternative microcontrollers.



TEMPERATURE SENSOR: The LM35 is associate integrated circuit detector that may be accustomed live temperature with associate electrical output proportional to the temperature (in oC). you'll live temperature a lot of accurately than a employing a thermistor. The sensor electronic equipment is sealed and not subject to oxidization, etc. The LM35 generates a better output voltage than thermocouples and will not need that the output voltage be amplified.

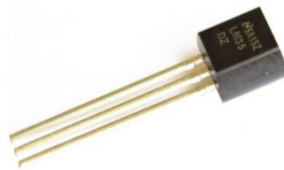

PULSE SENSOR: Heartbeat Sensor is an all around planned attachment and-play pulse sensor for Arduino. The sensor cuts onto a fingertip or ear cartilage and plugs directly into Arduino with some jumper links. It additionally incorporates an open-source checking application that charts your heartbeat continuously. The front side of the sensor is with the Heart logo. This is the side that connects with the skin. On the front you see a little circular opening, which is the place where the LED radiates through from the back, and there is additionally somewhat square under the LED. The square is a surrounding light sensor, precisely like the one utilized in cellphones, tablets, and PCs, to change the screen splendor in various light conditions. The LED focuses light into the fingertip or ear cartilage, or other slim tissue, and sensor peruses the light that ricochets back.

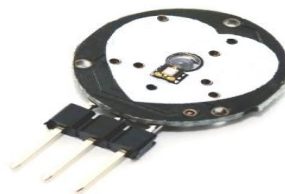

PIEZOELECTRIC SENSOR: The word piezoelectricity implies power occurring due to pressing issue. it's gotten from the Greek piezo or piezein (πιέζειν), that intends to crush or press, and electrical or electron (ήλεκτρον), that represents golden, associate degree archaic wellspring of electrical charge. The electricity impact is perceived

because the direct mechanical device cooperation between the mechanical and therefore the electrical state in glasslike materials with no reversal balance. the other electricity impact is employed underway of supersonic sound waves. The electricity impact may be a reversible interaction in this materials showing the direct electricity impact (the inner age of electrical charge happening due to associate degree applied mechanical power) likewise show the converse piezoelectric impact (the within age of a mechanical strain happening due to an applied electrical field).

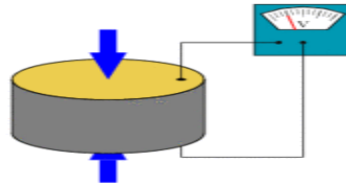

VOLTAGE SENSOR: A voltage sensor goes to be ready to verify and even monitor and live the voltage provide. it's then ready to take those measurements and switch them into a signal that one can then be ready to read. The signal can usually enter a specialised device for recording.



BATTERY: A battery could be a device that converts chemical energy on to electrical energy. It consists of a number of voltaic cells; every voltaic cell consists of 2 half cells connected serial by a conductive solution containing anions and cat ions. One half-cell includes electrolyte and also the conductor to that anions (negatively charged ions) migrate, i.e., the anode or negative electrode; the opposite half-cell includes electrolyte and also the electrode to that cat ions (positively charged ions) migrate, i.e., the cathode or positive electrode.

BUZZER: A buzzer may be a sound drooping device, which could be mechanical, mechanical device. Run of the mill employments of signals and beepers incorporate alert gadgets, clocks, and affirmation of shopper data, as an example, a mouse snap or keystroke. It produces predictable single tone sound simply by applying D.C voltage. Utilizing a fairly planned full framework, this kind may be utilised wherever large sound volumes ar needed.



LCD DISPLAY: This is a LCD Display intended for E-blocks. It is a 16 character, 2-line alphanumeric LCD show associated with a solitary 9-way D-type connector. This permits the gadget to be associated with most E-Block I/O ports. The LCD show requires information in a sequential organization, which is nitty gritty in the client direct beneath. The showcase likewise requires a 5V force supply. If it's not too much trouble,

take care not to surpass 5V, as this will make harm the gadget. The 5V is best created from the E-blocks Multipogrammer or a 5V fixed managed power.

LORAWAN: LORAWAN is a Low Power Wide Area Network (LPWAN) determination expected for remote battery worked gadgets in local, public or worldwide organization. LORAWAN target key prerequisites of Internet of things like secure bi-directional correspondence, portability and restriction administrations.

2. RESULTS AND DISCUSSION

Output 1

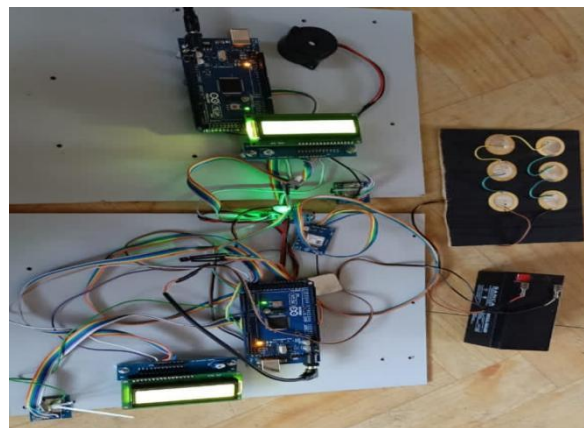

Output 2



Output 3



Output 4



Temperature increment expanded by the darling capacity it expected to be give like expanded level capacity measure. It was shown the light in the event of the officers were in the basic stages contact in the catch it rang the caution and furthermore expanded the temperature level. Simultaneously it shown the fighters IDs and their clinical records, for example, blood bunch. It was shown the light if there should arise an occurrence of the warriors were in the basic stages contact in the catch it rang the alert and furthermore expanded the temperature level. Simultaneously it shown the fighters IDs and their clinical records, for example, blood bunch from LCD show.

3. CONCLUSION

In this venture we give a safe and security framework for fighters to ensure them during war time. The framework additionally furnish a few offices to speak with the control room base segment at any crisis circumstance. A high level WSN innovation known as LORA is introduced here, that can be utilized for extremely long reach. Likewise well being boundaries checking sensors will screen the trooper condition persistently and alert the control alongside GPS area at some basic circumstance.

4. REFERENCES

- [1] Zourmand, N. W. Sheng, A. L. K. Hing, and M. AbdulRehman, “Human Counting and Indoor Positioning System Using WiFi Technology,” in Automatic Control and Intelligent Systems, Shah Alam. IEEE, October 2018, pp. 142–147. [Online]. Available: https://www.researchgate.net/publication/330253846_Human_Counting_and_Indoor_Positioning_System_Using_WiFi_Technology
- Wongeeun, C. Yoon-Seop, J. Yeonuk, and S. Junkuen, “Low-Power LoRa Signal-Based Outdoor Positioning Using Fingerprint Algorithm,” GoeInformation, vol. 7, no. 11, pp. 440–455, 2018. [Online]. Available: [10.3390/ijgi7110440;https://www.mdpi.com/2220-9964/7/11/440/pdf](https://www.mdpi.com/2220-9964/7/11/440/pdf)
- [2] J. Teel, “Bluetooth or WiFi – Which is Best for Your New Wireless Product?” 2018. [Online]. Available: <https://predictabledesigns.com/whattype-of-wireless-is-right-for-your-product-bluetooth-wifi/>
- [3] E. Notes, “LoRa Physical Layer & RF Interface,” 2018. [Online]. Available: <https://www.electronics-notes.com/articles/connectivity/lora/radio-rf-interface-physical-layer.php>
- [4] “Why LoRa?” [Online]. Available: <https://www.semtech.com/lora/whylora>

- [5] L. Alliance, “White Paper: A Technical Overview of LoRa and Lorawan,” 2015.[Online].Available:https://www.tuv.com/media/corporate/products_1/electronic_components_and_lasers/TUeV_Rheinland_Overview_LoRa_and_LoRaWANtmp.pdf
- [6] S. R. Sharan, W. Y. Qiao, and H. Seung-Hoon, “A survey on LPWA technology: LoRa and NB-IoT,” *ICT Express*, vol. 3, no. 1, 2017. [Online]. Available: 10.1016/j.ict.2017.03.004
- [7] L. A. T. C. R. P. Workgroup, “LoRaWANTM 1.1 Regional Parameters,” January 2018. [Online]. Available: <https://lora-alliance.org/resourcehub/lorawantm-regional-parameters-v11rb>
- [8] M. Communications and M. Commision, “Class Assignment No. 2 of 2015,” 2015. [Online]. Available: <https://www.mcmc.gov.my/resources/registered-assignments/register-of-class-assignments.aspx>
- [9] M. Communications and M. C. (MCMC), “Usage of Short Range Device (SRD) and Radio Frequency Identification Device (RFID),” 2015. [Online]. Available: <https://www.mcmc.gov.my/skmmgovmy/media/General/pdf/Public-Notice-RFID-SRD.pdf>
- [10] [11] M. Communications and M. Commision, “Class Assignmnet No. 1 of 2017,” 2017. [Online]. Available: <https://www.mcmc.gov.my/resources/registered-assignments/register-of-class-assignments.aspx>
- [11] [12] K. A. Ahmad, J. D. Segaran, F. R. Hashim, and M. T. Jusoh, “LoRa Propagation at 433 MHz in Tropical Climate Environment,” *Journal of Fundamental and Applied Sciences*, vol. 9, no. 3S, pp. 384–394, 2017. [Online]. Available: 10.4314/jfas.v9i3s.31;https://www.researchgate.net/publication/322809453_LoRa_propagation_at_433_MHz_in_tropical_climate_environment
- [12] [13] S. Daud, T. S. Yang, M. A. Romli, Z. A. Ahmad, N. Mahrom, and R. A. A. Raof, “Performance Evaluation of Low Cost LoRa Modules in IoT Applications ,” *IOP Conference Series: Materials Science and Engineering*, vol. 318, no. 1, 2018. [Online]. Available: 10.1088/1757- 899X/318/1/012053.